

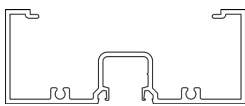







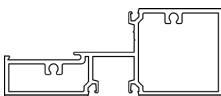
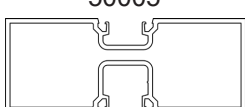

# FG-450 Part ID/Index

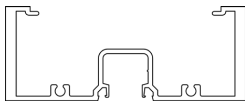
1-3/4" X 4-1/2" STOREFRONT  
SCREW SPLINE - NON THERMAL  
1/4" GLAZING

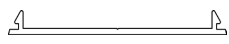
## FLUSH GLAZE SYSTEM

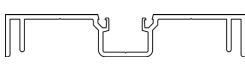
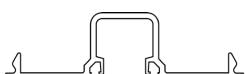
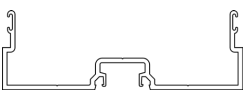
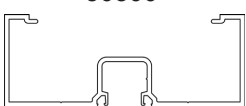
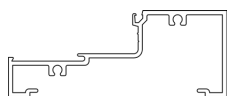
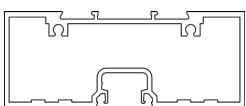







Part Number	Description	Length	Part Number	Description	Length
50001 	Head/Vertical Jamb	24' 2"	50104 	1/4" Glazing Bead	24' 2"
50002 	Mullion Adaptor	24' 2"	50111 	Horizontal/Sill	24' 2"
50005 	Vertical	24' 2"	50137 	Sub Sill	24' 2"
50013 	Heavy Head/Vertical	24' 2"	50242 	Receptor	24' 2"
50026 	Snap In Plate	22' 0"	50244 	Receptor Bead	24' 2"
50030 	Expansion Mullion Female	24' 2"	50335 	Mullion Adaptor - Deep	24' 2"
50031 	Expansion Mullion Male	24' 2"	50500 	Open Back Door Jamb	21' 8"
50103 	Horizontal/Sill	24' 2"	50504 	Door Head	24' 6"

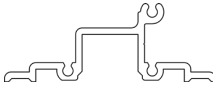

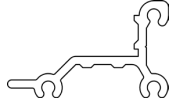
# FG-450 Part ID/Index

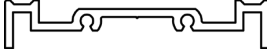
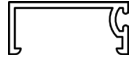
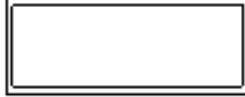
1-3/4" X 4-1/2" STOREFRONT  
SCREW SPLINE - NON THERMAL  
1/4" GLAZING

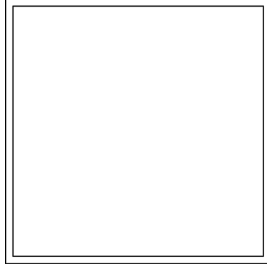
## FLUSH GLAZE SYSTEM

Part Number	Description	Length	Part Number	Description	Length
50519 	1/4" Glass Bead at Transom	12' 6"	50634 	Shear Block Head	1.250"
50526 	Door Stop 1/4" Sheer Block Door	21' 4"	50635 	Shear Block Sill	1.250"
50529 	Applied Door Stop Base	13' 0"	50638 	Shear Block Door Head	1.50"
50530 	Door Stop	13' 0"	990946 	4-1/2" x 1-3/4" x .125 Tube	24' 2"
50534 	Filler at Transom	13' 0"	990949 	4-1/2" x 4-1/2" x .125 Tube	24' 2"
50587 	Snap-In 1/4" Pocket Filler	13'			



# FG-450 Part ID/Index

1-3/4" X 4-1/2" STOREFRONT  
SCREW SPLINE - NON THERMAL  
1/4" GLAZING







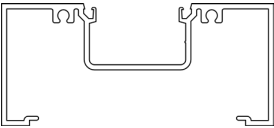
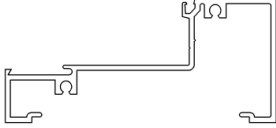

## FLUSH GLAZE SYSTEM

Part Number	Description	Length	Part Number	Description	Length
50127	4-1/2" - 4-1/2" Sill Horizontal	24' 2"	50317	Corner Plain No Pocket	24' 2"
50314	Single Pocket Corner Female	24' 2"	50334	Corner Mullion 135 Degree	24' 2"
50315	Single Pocket Corner Male	24' 2"	SK-050	Assembly Screw	#12x1"
50316	Double Pocket Corner	24' 2"	SB-450	Setting Block	1/2" x 1/2" x 4"
			WS2500	Glazing Gasket	500FT

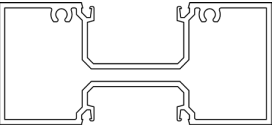
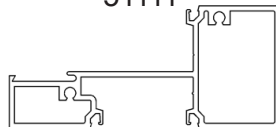
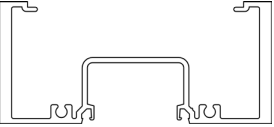

# FG-451 Part ID/Index

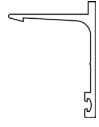



2" X 4-1/2" STOREFRONT  
SCREW SPLINE - NON THERMAL  
FLUSH GLAZE SYSTEM

Part Number	Description	Length	Part Number	Description	Length
51001 	Head/Vertical	24' 3"	51103 	Horizontal Sill	24' 2"
51002 	Mullion Adaptor Standard	24' 2"	51104 	1" Glazing Bead	24' 2"
51005 	Double Pocket Mullion	24' 2"	51111 	Horizontal Sill	24' 2"
51013 	Heavy Head Vertical	24' 2"	50137 	Sub Sill	24' 2"
50026 	Snap In Plate	22' 0"	50242 	Receptor	24' 2"
51030 	Expansion Mullion Female	24' 2"	50244 	Receptor Bead	24' 2"
51031 	Expansion Mullion Male	24' 2"	51429 	Glazing Adaptor 1/4" Glass	24' 2"

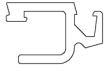

# FG-451 Part ID/Index

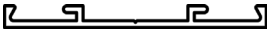
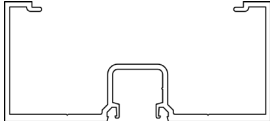
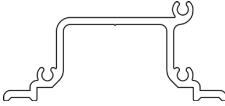
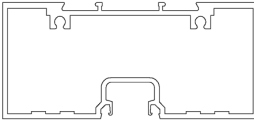
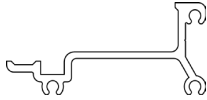
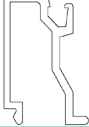
## 2" X 4-1/2" STOREFRONT SCREW SPLINE - NON THERMAL FLUSH GLAZE SYSTEM

Part Number	Description	Length	Part Number	Description	Length
51431 	Glazing Adaptor 1/2" Glass	24' 2"	50534 	Filler at Transom	13'
51487 	Snap-In Filler	13'	50536 	Filler at Transom Door Jamb	13'
51500 	Door Jamb	21' 6"	51634 	Shear Block Head	1.25"
51504 	Door Frame Head	24' 2"	51635 	Shear Block Sill	1.25"
51514 	1" Glass Stop at Transom	12' 6"	990910 	1" x 1" x .125 Tube	24' 2"
50519 	1/4" Glass Stop	12' 6"			



# FG-451 Part ID/Index

2" X 4-1/2" STOREFRONT  
SCREW SPLINE - NON THERMAL  
FLUSH GLAZE SYSTEM

Part Number	Description	Length	Part Number	Description	Length
990947	4-1/2" x 2" .125 Tube	24' 2"	52127	4-1/2" High Sill Horizontal	24' 2"
990949	4-1/2" x 4-1/2" x .125 Tube	24' 2"	51314	Single Pocket Corner Female	24' 2"
WS2500	Glazing Gasket	500FT	51315	Single Pocket Corner Male	24' 2"
100404	Threshold 4"	12' 4"	51316	Double Pocket Corner	24' 2"
100502	Threshold 5"	12' 4"			
100700	Threshold 7"	12' 6"			



# FG-451 Part ID/Index

2" X 4-1/2" STOREFRONT  
SCREW SPLINE - NON THERMAL  
FLUSH GLAZE SYSTEM



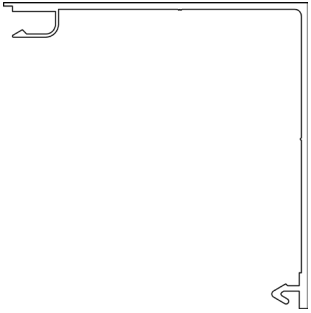
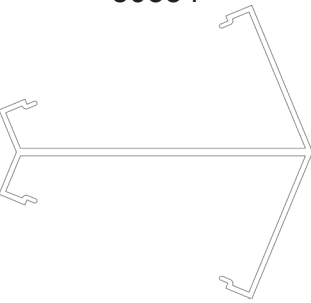
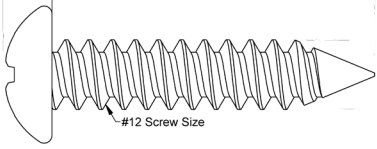
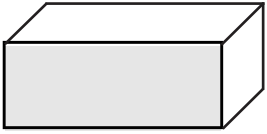

---

Part Number	Description	Length
50317 	Corner Mullion No Pocket	24' 2"
50334 	135 Degree Corner Mullion	24' 2"
SK-050 	Assembly Screw	#12x1"
SB-451 	Setting Block	5/8" x 11/8" x 4"

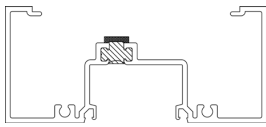
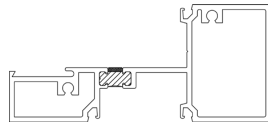
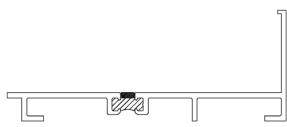

# FG-451T Part ID/Index

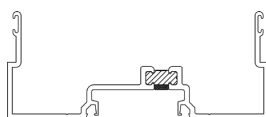
## 2" X 4-1/2" STOREFRONT SCREW SPLINE - THERMAL FLUSH GLAZE SYSTEM

Part Number	Description	Length	Part Number	Description	Length
52001 	Head/Vertical	24' 2"	52111 	Horizontal Sill	24' 2"
52002 	Mullion Adaptor	24' 2"	52137 	Sub Sill	24' 2"
52013 	Heavy Head Vertical	24' 2"	52242 	Head Receptor	24' 2"
52026 	Snap-In Plate	24' 2"	50244 	Receptor Bead	24' 2"
52030 	Expansion Mullion Female	24' 2"	51500 	Open Back Door Jamb	22' 2"
52031 	Expansion Mullion Male	24' 2"	51504 	Single Action Door Head	24' 2"
52103 	Horizontal Sill	24' 2"	51514 	1" Glass Stop at Transom	12' 6"
51104 	1" Glazing Bead	24' 2"	50519 	1/4" Glass Bead at Transom	12' 6"





# FG-451T Part ID/Index



## 2" X 4-1/2" STOREFRONT SCREW SPLINE - THERMAL FLUSH GLAZE SYSTEM

Part Number	Description	Length	Part Number	Description	Length
50526	Door Stop for 1/4" Pocket	21' 4"	52127	High Sill	24' 2"
51634	Head Shear Block Mill Finish	1.250"			
52635	Sill Shear Block Mill Finish	1.250"	52314	Single Pocket Corner Female	24' 2"
50638	Door Head Shear Block Mill Finish	1.50"			
100404	Threshold 4"	12' 4"	52315	Single Pocket Corner Male	24' 2"
100502	Threshold 5"	12' 4"			
100700	Threshold 7"	12' 6"	52316	Single Pocket Corner	24' 2"

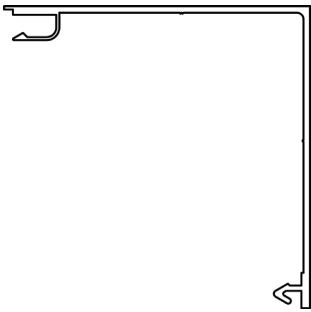

# FG-451T Part ID/Index

2" X 4-1/2" STOREFRONT  
SCREW SPLINE - THERMAL  
FLUSH GLAZE SYSTEM

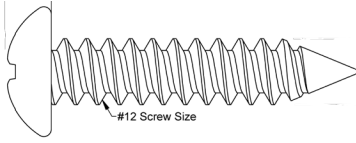
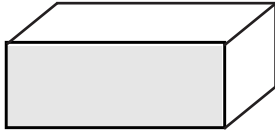
Part Number	Description	Length
50317 	Corner Mullion No Pocket	24' 2"
WS2500 	Glazing Gasket	500 FT
SK-050 	Assembly Screw	#12x1"
SB-451 	Setting Block	5/8" x 1 1/8" x 4"